

B3 IM1001

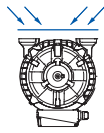

B8 IM1071

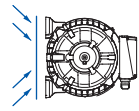

B6 IM1051

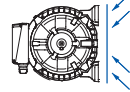

B7 IM1061

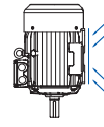

V5 IM1011

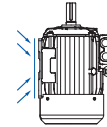

V6 IM1031

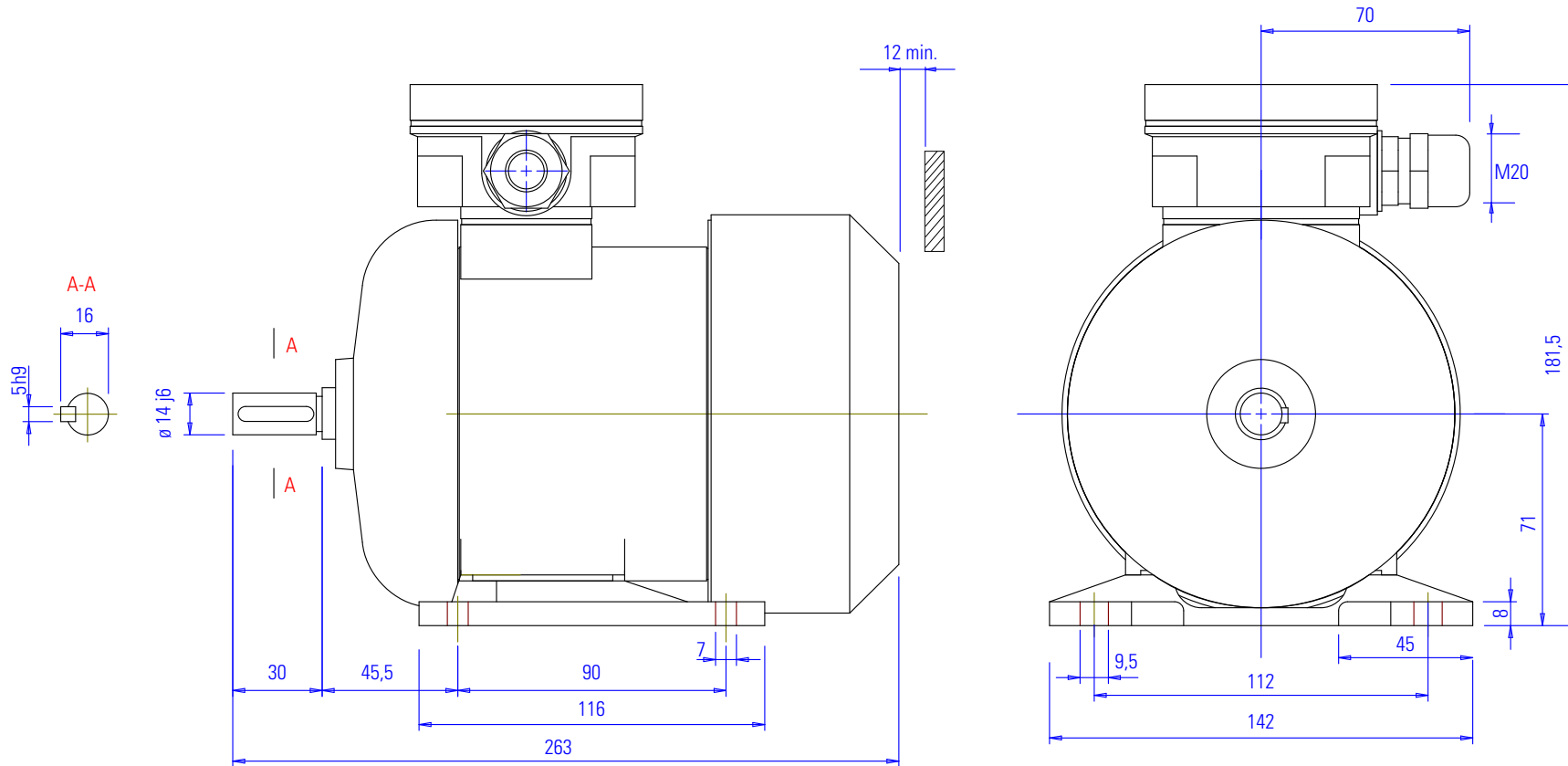
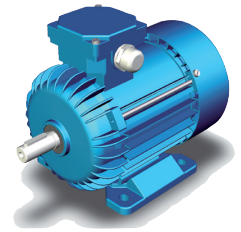

Cantoni®
GROUP



Sh 71 - XC2; XC4;
2SIE 71 - XC6; XC8;

- Sh 71 - XC 2 N° 24060
- Sh 71 - XC 4 N° 24410
- Sh 71 - XC 6 N° 3135
- Sh 71 - XC 8 N° 4110

