

B8 IM 1074

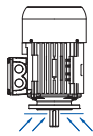

V18 IM 3611

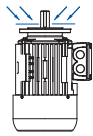

V19 IM 3631

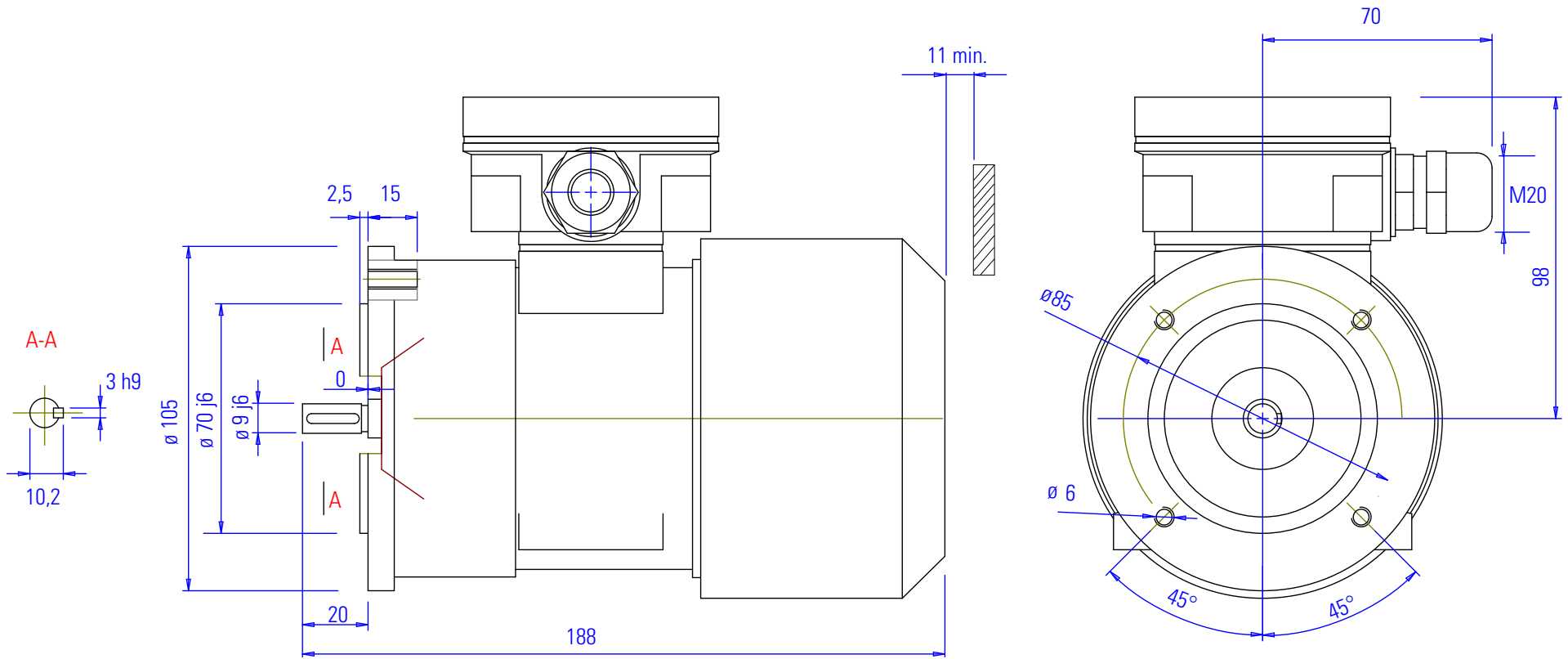
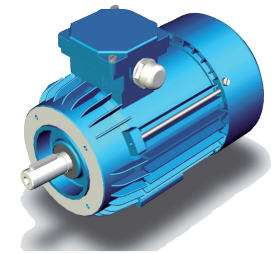

Cantoni[®]
GROUP



SKh 56 - A2; A4; A6;

SKh 56 - A 2	N° 1003
SKH 56 - A 4	N° 2003
SKH 56 - A 6	N°

